

# Aquos 15





STOVE STRUCTURE CODE 7014027 (BAFA)  
EAN 8033123615051





## STEEL

-  ANTHRACITE  
6913008  
EAN 8033123612784
-  IVORY  
6913010  
EAN 8033123612753
-  RED  
6913009  
EAN 8033123612760
-  SILVER  
6913007  
EAN 8033123612777
-  LIGHT BRONZE  
6915018  
EAN 8033123616386

## MAJOLICA

-  IVORY  
6913013  
EAN 8033123612791
-  BRILLIANT BLACK  
6913011  
EAN 8033123612807
-  RED  
6913012  
EAN 8033123612661

## STONE

-  SERPENTINO  
6913014  
EAN 8033123612746
-  WHITE  
6914001  
EAN 8033123614764

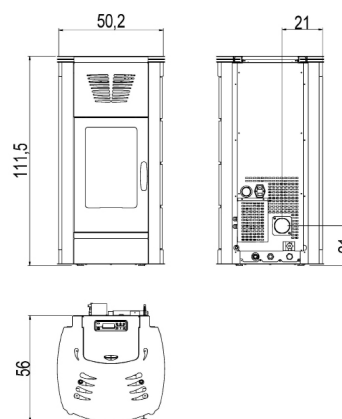

## EXTRA



Connection to the heating system



Overheating protection



Cast iron burning pot



Water temperature sensor



Connection to the external thermostat



Back exhaust



Hydraulic kit included



Handgrip against burn



Air temperature sensor



Daily weekly programming



Ventilation

## TECHNICAL DATAS

Nominal power	kW	15,4
Reduced power	kW	4,4
Nominal water useful power	kW	13
Reduced water useful power	kW	3
Nominal efficiency	%	92,1
Reduced efficiency	%	95
Heating volume (min-max)	m <sup>3</sup>	106 - 370
Nominal CO at 13% O <sub>2</sub>	%	0,011
Reduced CO at 13% O <sub>2</sub>	%	0,040
Nominal dust content at 13% O <sub>2</sub>	mg/Nm <sup>3</sup>	18
Boiler capacity (H <sub>2</sub> O)	l	14
Hopper capacity	kg	29
Combustible		Pellet ø6
Hourly consumption (min-max)	kg/h	0,90 - 3,40
Autonomy (min-max)	h	32,2 - 8,5
Ignition electrical absorption (max)	W	420
Operating electrical absorption (max)	W	120
Supply and frequency	V - Hz	230 - 50
Chimney flue depression	Pa	10
Exhaust diameter	mm	80
Combustion air inlet diameter	mm	50
Mass of smoke (min-max)	g/sec	4,5 - 10,4
Exhaust fumes temperature (max)	°C	145
Net weight	kg	157-168-202
Gross weight	kg	167-178-212

## PACKAGING AND STOCKING

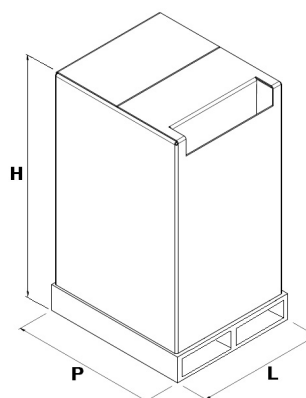

L (cm)	68
H (cm)	133
P (cm)	80

## LINING PACKING

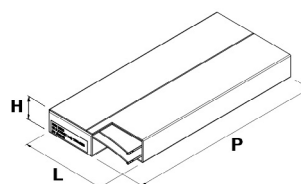

LINING	L (cm)	H (cm)	P (cm)
Steel	96	8	46
Majolica	50	30	47
Stone	45	27	23



EN 14785:2006



BImSchV 2015



Regensburg



Bundesamt für Wirtschaft und Ausfuhrkontrolle (BAFA)

München

Stuttgart

Aachen